

Garų surinktuvai

Garų surinktuvas su riebaliniais filtrais

AWFRN-d-B-L-H nerūdijančio plieno

AWFR-d-B-L-H cinkuoto plieno

$L_1 = 40 \text{ mm}$ (100÷315), $L_1 = 65 \text{ mm}$ (355÷800).

Maksimalus leistinas oro srauto greitis per riebalinį filtrą $V_F = 1 \text{ m/s}$.
Lakštų sujungimai kniedyti.

Riebalinius filtrus rekomenduojame plauti nuriebalinančiame tirpale ne rečiau kaip kartą per savaitę. Filtrus užmerkti, kai jie dar karšti.

Nurodyta garų surinktuvų su riebalų filtrais kaina.

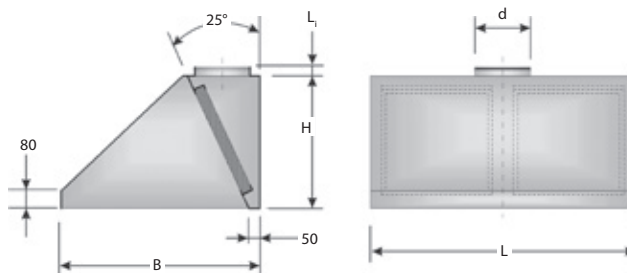
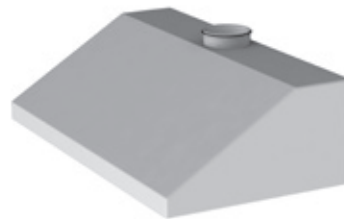

d, mm	B, mm	H, mm	Riebalinių filtrų tipas ir skaičius, vnt.	Oro kiekis, m ³ /h	Masė (su riebaliniais filtrais), kg	Δ Pa, švarus-užterštas	Kodas	L				
								900	1200	1500	1800	2100
160	800	400	RF-212 (x1)	450	14	30-91	708028432					
200	800	400	RF-212 (x2)	900	20	36-97	708083113					
200	800	400	RF-212 (x2)	900	29	36-97	1018026					
200 (x2)	800	400	RF-212 (x3)	1350	36	29-90	708083119					
200 (x2)	800	400	RF-212 (x3)	1350	40	29-90	708100078					
200	800	600	RF-222 (x1)	900	21	36-97	708022976					
315	800	600	RF-222 (x2)	1800	29	30-91	708000022					
315	800	600	RF-222 (x2)	1800	42	30-91	708026941					
250 (x2)	800	600	RF-222 (x3)	2700	52	35-96	708048940					
250 (x2)	800	600	RF-222 (x3)	2700	57	35-96	708000093					
								AWFR				
160	800	400	RF-212 (x1)	450	16	30-91	708100035					
200	800	400	RF-212 (x2)	900	22	36-97	708100022					
200	800	400	RF-212 (x2)	900	32	36-97	708121675					
200 (x2)	800	400	RF-212 (x3)	1350	39	29-90	708128415					
200 (x2)	800	400	RF-212 (x3)	1350	44	29-90	708127702					
200	800	600	RF-222 (x1)	900	24	36-97	708100013					
315	800	600	RF-222 (x2)	1800	33	30-91	1021378					
315	800	600	RF-222 (x2)	1800	46	30-91	708149988					
250 (x2)	800	600	RF-222 (x3)	2700	56	35-96	708128416					
250 (x2)	800	600	RF-222 (x3)	2700	63	35-96	1021385					

UŽSAKYMO PAVYZDYS: garų rinktuvas AWFRN-160-800-900-400.

Garų surinktuvas su riebaliniais filtrais

AWVFRN-d-B-L-H nerūdijančio plieno

AWVFR-d-B-L-H cinkuoto plieno

$L_1 = 40 \text{ mm}$ (100÷315), $L_1 = 65 \text{ mm}$ (355÷800).

Maksimalus leistinas oro srauto greitis per riebalinį filtrą $V_F = 1 \text{ m/s}$.
Lakštų sujungimai kniedyti.

Riebalinius filtrus rekomenduojame plauti nuriebalinančiame tirpale ne rečiau kaip kartą per savaitę. Filtrus užmerkti, kai jie dar karšti.

Nurodyta garų surinktuvų su riebalų filtrais kaina.

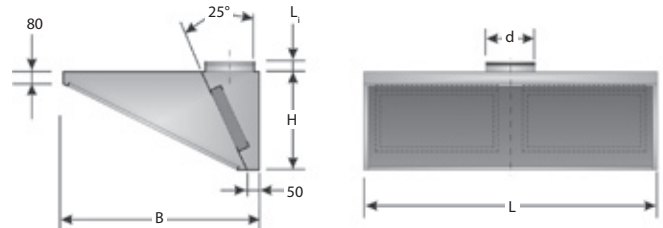
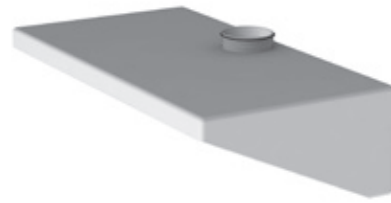

d, mm	B, mm	H, mm	Riebalinių filtrų tipas ir skaičius, vnt.	L				900	1200	1500	1800	2100
				Oro kiekis, m ³ /h	Masė (su riebaliniais filtrais), kg	Δ Pa, švarus-užterštas	Kodas	AWVFRN				
160	800	400	RF-212 (x1)	450	14	30-91	708016964					
200	800	400	RF-212 (x2)	900	19	36-97	708016961					
200	800	400	RF-212 (x2)	900	28	36-97	708016962					
200 (x2)	800	400	RF-212 (x3)	1350	34	29-90	708055408					
200 (x2)	800	400	RF-212 (x3)	1350	38	29-90	708016969					
200	800	600	RF-222 (x1)	900	19	36-97	708055539					
315	800	600	RF-222 (x2)	1800	27	30-91	708064182					
315	800	600	RF-222 (x2)	1800	38	30-91	1018385					
250 (x2)	800	600	RF-222 (x3)	2700	47	35-96	708056410					
250 (x2)	800	600	RF-222 (x3)	2700	52	35-96	708000105					
								AWVFR				
160	800	400	RF-212 (x1)	450	15	30-91	1021391					
200	800	400	RF-212 (x2)	900	21	36-97	708145661					
200	800	400	RF-212 (x2)	900	30	36-97	708154983					
200 (x2)	800	400	RF-212 (x3)	1350	37	29-90	708153543					
200 (x2)	800	400	RF-212 (x3)	1350	42	29-90	708153544					
200	800	600	RF-222 (x1)	900	21	36-97	1021392					
315	800	600	RF-222 (x2)	1800	30	30-91	1021394					
315	800	600	RF-222 (x2)	1800	42	30-91	708164185					
250 (x2)	800	600	RF-222 (x3)	2700	52	35-96	1021393					
250 (x2)	800	600	RF-222 (x3)	2700	57	35-96	1021395					

UŽSAKYMO PAVYZDYS: garų rinktuvas AWVFRN-160-800-900-400.

Garų surinktuvas su riebaliniais filtrais

AMFRN-d-B-L-H nerūdijančio plieno

AMFR-d-B-L-H cinkuoto plieno

$L_1 = 40 \text{ mm}$ (100÷315), $L_2 = 65 \text{ mm}$ (355÷800).

Maksimalus leistinas oro srauto greitis per riebalinį filtrą $V_F = 1 \text{ m/s}$.
Lakštų sujungimai kniedyti.

Riebalinius filtrus rekomenduojame plauti nuriebalinančiame tirpale ne rečiau kaip kartą per savaitę. Filtrus užmerkti, kai jie dar karšti.

Nurodyta garų surinktuvų su riebalų filtrais kaina.

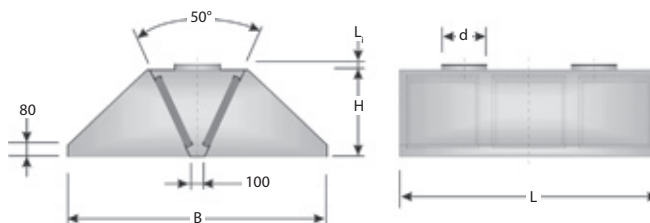
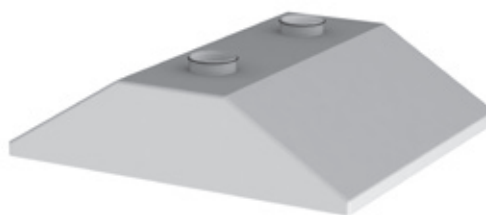

L								900	1200	1500	1800	2100
d, mm	B, mm	H, mm	Riebalinių filtrų tipas ir skaičius, vnt.	Oro kiekis, m ³ /h	Masė (su riebaliniais filtrais), kg	Δ Pa, švarus-užterštas	Kodas	AMFRN				
200	1600	400	RF-212 (x2)	900	31,0	36-97	1021396					
315	1600	400	RF-212 (x4)	1800	42,0	30-91	1021397					
315	1600	400	RF-212 (x4)	1800	49,0	30-91	1021398					
250 (x2)	1600	400	RF-212 (x6)	2700	60,0	35-96	1021399					
250 (x2)	1600	400	RF-212 (x6)	2700	67,0	35-96	1021400					
315	1600	600	RF-222 (x2)	1800	44,0	30-91	1021401					
400	1600	600	RF-222 (x4)	3600	61,0	36-97	1021404					
400	1600	600	RF-222 (x4)	3600	70,0	36-97	1021405					
355 (x2)	1600	600	RF-222 (x6)	5400	87,0	35-96	1021406					
355 (x2)	1600	600	RF-222 (x6)	5400	95,0	35-96	1021407					
								AMFR				
200	1600	400	RF-212 (x2)	900	35,0	36-97	708164194					
315	1600	400	RF-212 (x4)	1800	47,0	30-91	708137619					
315	1600	400	RF-212 (x4)	1800	54,0	30-91	1003460					
250 (x2)	1600	400	RF-212 (x6)	2700	66,0	35-96	1021424					
250 (x2)	1600	400	RF-212 (x6)	2700	73,0	35-96	708154047					
315	1600	600	RF-222 (x2)	1800	49,0	30-91	1021425					
400	1600	600	RF-222 (x4)	3600	67,0	36-97	708130089					
400	1600	600	RF-222 (x4)	3600	76,0	36-97	1021426					
355 (x2)	1600	600	RF-222 (x6)	5400	95,0	35-96	1021429					
355 (x2)	1600	600	RF-222 (x6)	5400	104,0	35-96	708127705					

UŽSAKYMO PAVYZDYS: garų rinktuvas AMFRN-200-1600-900-400.

Garų surinktuvas su riebaliniais filtrais

AMVFRN-d-B-L-H nerūdijančio plieno

AMVFR-d-B-L-H cinkuoto plieno

$L_1 = 40 \text{ mm}$ (100÷315), $L_1 = 65 \text{ mm}$ (355÷800).

Maksimalus leistinas oro srauto greitis per riebalinį filtrą $V_F = 1 \text{ m/s}$.

Lakštų sujungimai kniedyti.

Riebalinius filtrus rekomenduojame plauti nuriebalinančiame tirpale ne rečiau kaip kartą per savaitę.

Filtrus užmerkti, kai jie dar karšti.

Nurodyta garų surinktuvų su riebalų filtrais kaina.

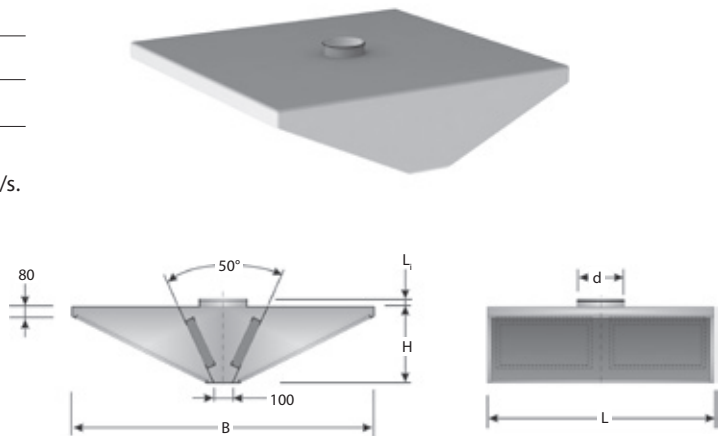

L								900	1200	1500	1800	2100
d, mm	B, mm	H, mm	Riebalinių filtrų tipas ir skaičius, vnt.	Oro kiekis, m ³ /h	Masė (su riebaliniais filtrais), kg	Δ Pa, švarus-užterštas	Kodas	AWVFRN				
200	1600	400	RF-212 (x2)	900	29,0	36-97	708000092					
315	1600	400	RF-212 (x4)	1800	40,0	30-91	708010005					
315	1600	400	RF-212 (x4)	1800	46,0	30-91	708064196					
250 (x2)	1600	400	RF-212 (x6)	2700	57,0	35-96	708016967					
250 (x2)	1600	400	RF-212 (x6)	2700	63,0	35-96	708024752					
315	1600	600	RF-222 (x2)	1800	39,0	30-91	1021414					
400	1600	600	RF-222 (x4)	3600	55,0	36-97	1019322					
400	1600	600	RF-222 (x4)	3600	62,0	36-97	1021417					
355 (x2)	1600	600	RF-222 (x6)	5400	79,0	35-96	708064200					
355 (x2)	1600	600	RF-222 (x6)	5400	86,0	35-96	1021420					
								AWVFR				
200	1600	400	RF-212 (x2)	900	32,0	36-97	708164202					
315	1600	400	RF-212 (x4)	1800	44,0	30-91	708164203					
315	1600	400	RF-212 (x4)	1800	51,0	30-91	1021408					
250 (x2)	1600	400	RF-212 (x6)	2700	63,0	35-96	708164204					
250 (x2)	1600	400	RF-212 (x6)	2700	69,0	35-96	708125193					
315	1600	600	RF-222 (x2)	1800	43,0	30-91	1021409					
400	1600	600	RF-222 (x4)	3600	60,0	36-97	1021410					
400	1600	600	RF-222 (x4)	3600	68,0	36-97	1021411					
355 (x2)	1600	600	RF-222 (x6)	5400	85,0	35-96	1021412					
355 (x2)	1600	600	RF-222 (x6)	5400	93,0	35-96	1021413					

UŽSAKYMO PAVYZDYS: garų rinktuvas AMVFRN-200-1600-900-400.