

komfovent[®]

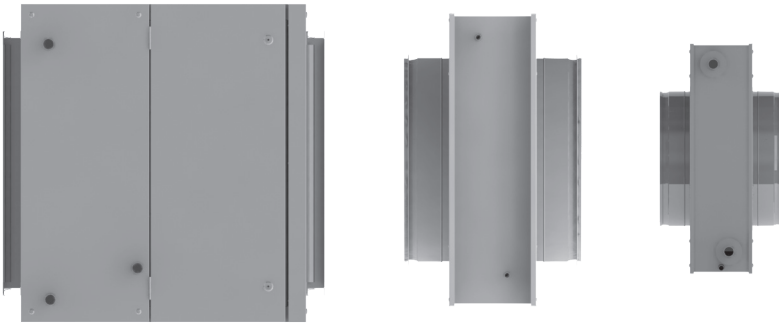

DUCT HEAT EXCHANGERS INSTALLATION AND MAINTENANCE SERVICE MANUAL

EN Installation and service Manual

Content

NOMENKLATURE	4
TECHNICAL INFORMATION	4
INSTALLATION OF HEAT EXCHANGERS	9
CLEANING AND INSPECTION OF HEAT EXCHANGERS	10
WATER TRAP INSTALLATION	11
Water trap installation for a unit section mounted on the suction side	11
Water trap installation for a unit section mounted on the pressure side	11



This symbol indicates that this product is not to be disposed of with your household waste, according to the WEEE Directive (2002/96/EC) and your national law. This product should be handed over to a designated collection point, or to an authorised collection site for recycling waste electrical and electronic equipment (EEE). Improper handling of this type of waste could have a possible negative impact on the environment and human health due to potentially hazardous substances that are generally associated with EEE. At the same time, your cooperation in the correct disposal of this product will contribute to the effective usage of natural resources. For more information about where you can drop off your waste equipment for recycling, please contact your local city office, waste authority, approved WEEE scheme or your household waste disposal service.

NOMENKLATURE

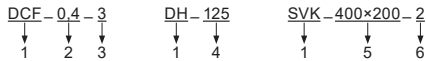

- 1 – key of heat exchanger name
- DCF – duct freon cooler with rectangular connections
- DCW – duct water cooler with rectangular connections
- DH – duct water heater with round connections
- DHCW – duct water cooler with round connections
- SVK – duct water heater with rectangular connections
- 2 – nominal air flow (m³/h) / 1000
- 3 – cooling capacity at nominal parameters (kW)
- 4 – connection diameter Ø, mm
- 5 – flange dimensions
- 6 – piping row count

TECHNICAL INFORMATION

Duct heat exchangers are mounted outside the unit. Heat exchangers are designed to heat/cool cleaned air in the ventilation systems. Coils are made of copper tubes and aluminium plates as standard. The housings of heat exchangers are made of galvanised steel (fig. 1a)

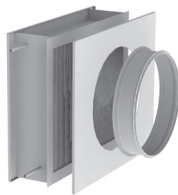

Fig. 1a

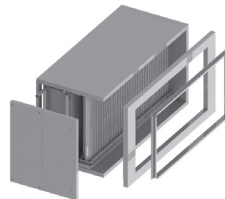

Fig. 1b

Coolers with rectangular connections are mounted in shield sections (fig. 1b). Shield thickness is 45 mm, with mineral stone wool ($\lambda = 0,037 \text{ W/mK}$). The case can be painted in RAL 7035.

Cooler section is assembled with a drop separator and a drain tray (drain tray pipe Ø32 mm). The connecting flanges of cooler is L20.

The control of heat exchangers is provided in control automatics.

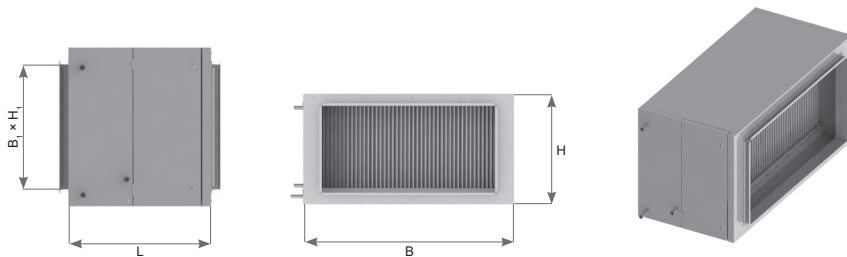
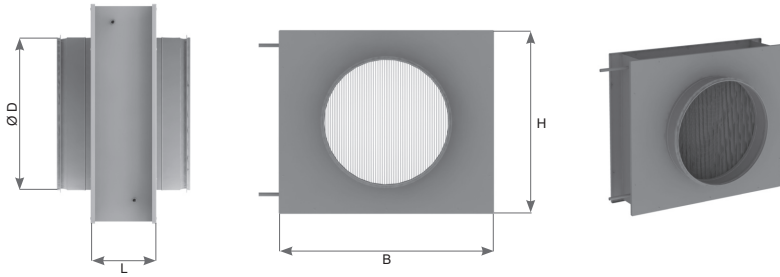
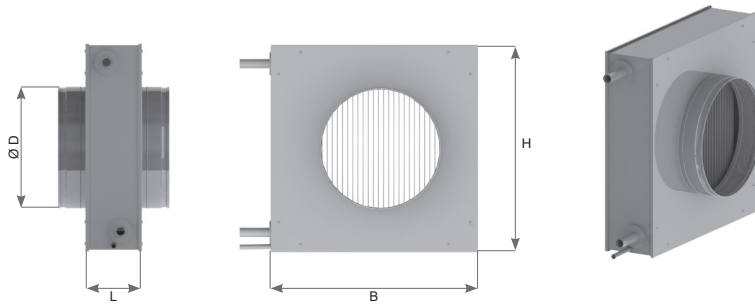

Fig. 2. Air cooler/heater section with rectangular connections

Air cooler/heater section with rectangular connections is shown in fig. 2.



a)



b)

Fig. 3. Heat exchangers with round connections (a) – heater, b) – cooler)

There are shown water heat exchangers with round connections in fig. 3. Coolers are assembled with drain tray (drain tray pipe $\varnothing 15$ mm).

Maximum allowable fluid pressure for water heat exchangers – 21 bar. Minimum / maximum fluid temperature – $-21/130$ °C.

Temperature difference between incoming fluid and outgoing air must be at least 3 °C.

Maximum allowable fluid pressure for freon heat exchangers – 42 bar. Minimum / maximum fluid temperature – $-20/80$ °C.

Maximum recommended air flow velocity through heat exchanger – 3 m/s.



	Attention: Earthing must be installed according EN61557 BS 7671 !
	Note: It is a must to mount the drainage siphon.

Table 1. Water and evaporative coolers with rectangular connections

Type	Supply air volume, m ³ /h	Air temper. in/out, °C	Internal fluid	Capacity, kW	Air pressure drop*, Pa	Hydraulic pressure drop, kPa	B×H×L, mm	Pipe connection	Internal volume, dm ³	B1×H1, mm	Weight, kg
DCF-0,4-3	400	30/18	R410A	2,8	16	0,4	600×550×390	½" /22 mm	0,9	300×400	40
DCW-0,4-3			Water 7/12	2,6	30	30,7	505×550×390	½"	1,6		33
DCF-0,5-3	500		R410A	3,5	19	0,6	600×550×390	½" /22 mm	0,9	400×300	40
DCW-0,5-3			Water 7/12	3,3	30	52,8	600×550×390	½"	1,9		35
DCF-0,7-5	700		R410A	4,8	22	0,6	705×610×390	½" /22 mm	1,8	500×400	49
DCW-0,7-5			Water 7/12	4,2	22	6,9	705×610×390	½"	2,6		42
DCF-0,9-6	900		R410A	6,2	29	0,9	705×610×390	½" /22 mm	1,8	500×400	49
DCW-0,9-6			Water 7/12	5,5	30	7,9	705×610×390	¾"	2,8		45
DCF-1,2-8	1200		R410A	8,3	43	1,5	705×610×390	½" /22 mm	1,8	500×400	49
DCW-1,2-8			Water 7/12	7,4	46	12,8	705×610×390	¾"	2,8		45
DCF-1,4-10	1400		R410A	9,7	74	11,8	705×610×390	½" /22 mm	2,3	500×400	51
DCW-1,4-9			Water 7/12	8,7	61	16,7	705×610×390	¾"	2,8		45
DCF-1,6-11	1600		R410A	11,1	78	16,4	755×610×420	½" /22 mm	2,5	500×400	56
DCW-1,6-11			Water 7/12	10	65	22,2	755×610×420	¾"	3,0		46
DCF-2,0-14	2000		R410A	13,8	71	30,7	920×610×420	5/8" /22 mm	3,1	700×400	65
DCW-2,0-13			Water 7/12	12,8	60	38	920×610×420	¾"	3,6		57
DCF-2,5-17	2500		R410A	16,9	67	14,9	1080×670×420	5/8" /22 mm	7,5	800×400	79
DCW-2,5-17			Water 7/12	15,5	63	16,6	1080×670×420	1"	8,4		65
DCF-3,0-20	3000		R410A	20,8	92	22,1	1080×670×420	5/8" /22 mm	7,6	800×400	79
DCW-3,0-20			Water 7/12	18,7	102	23	1080×670×420	1"	8,4		69
DCF-4,0-27	4000	R410A	26,9	94	45,6	1220×730×420	5/8" /22 mm	9,8	900×500	97	
DCW-4,0-27		Water 7/12	25,2	106	38,4	1220×730×420	1"	10,7		82	
DCF-4,5-31	4500	R410A	30,3	95	35,5	1220×790×420	¾" /22 mm	10,9	900×600	103	
DCW-4,5-30		Water 7/12	28,8	108	62	1220×790×420	1"	11,9		87	
DCF-7,0-48-2	7000	R410A	2×24,2	102	10,2	1500×790×480	2×¾"/2×22mm	7,7	1200×600	125	
DCW-7,0-47		Water 7/12	44,5	100	35,5	1500×790×420	1 ½"	10,4		105	

* with droplet eliminator

Table 2. Evaporative coolers with rectangular connections adapted to external condensers MOU

Type	Supply air volume, m ³ /h	Air temper. in/out, °C	Internal fluid	Capacity, kW	Air pressure drop*, Pa	Hydraulic pressure drop, kPa	B×H×L, mm	Pipe connection	Internal volume, dm ³	B1×H1, mm	Weight, kg
DCF-0,4-3	400	30/18,5	R410A	2,6	16	0,4	600×550×390	½" /22 mm	0,9	300×400	40
DCF-0,5-3	500	30/18,7		3,2	20	0,5	600×550×390	½" /22 mm	0,9	400×300	40
DCF-0,7-5	700	30/16,8		5,3	22	0,7	705×610×390	½" /22 mm	1,8	500×400	49
DCF-0,9-6	900	30/16,0		7,4	30	1,2	705×610×390	½" /22 mm	1,8	500×400	49
DCF-1,2-8	1200	30/17,2		8,9	45	1,7	705×610×390	½" /22 mm	1,8	500×400	49
DCF-1,4-10	1400	30/16,8		10,7	74	14,3	705×610×390	½" /22 mm	2,3	500×400	51
DCF-1,6-11	1600	30/18,4		10,7	79	15,3	755×610×420	½" /22 mm	2,5	500×400	56
DCF-2,0-14	2000	30/17,7		14,2	71	32,3	920×610×420	5/8" /22 mm	3,1	700×400	65
DCF-2,5-17	2500	30/18,7		15,8	67	13,2	1080×670×420	5/8" /22 mm	7,5	800×400	79
DCF-3,0-20-2	3000	30/17,7		2×10,6	79	12,6	1080×670×420	2×½" /2×22mm	4,5	800×400	79
DCF-4,0-27-2	4000	30/17,7		2×14,2	80	24,6	1220×730×420	2×5/8" /2×22mm	5,7	900×500	92
DCF-4,5-31-2	4500	30/17,6		2×16,1	82	39,1	1220×790×420	2×5/8" /2×22mm	6,3	900×600	98
DCF-7,0-48-3	7000	30/17,9		3×16,2	100	13,2	1500×790×480	3×5/8" /3×22mm	8,0	1200×600	131

* with droplet eliminator

Table 3. Duct water heat exchangers with round connections

Type	Supply air volume, m ³ /h	Air temp. in/out, °C	Fluid	Capacity, kW	Air pressure drop, Pa	Hydraulic pressure drop, kPa	B×H×L, mm	Pipe connection	Internal volume, dm ³	ØD, mm	Weight, kg
DH-125	450	10/22	Water 60/40	1,8	44	2,2	335×295×152	½"	0,9	125	6,15
DHCW-125		26/18	Water 7/12	1,4	69	11,6	335×335×164		1,2		11,13
DH-160	450	10/22	Water 60/40	1,8	44	2,2	335×295×152		0,9	160	6,15
DHCW-160		26/18	Water 7/12	1,4	69	11,6	335×335×164		1,2		11,13
DH-200	900	10/22	Water 60/40	3,6	101	4,5	360×320×152		1,1	200	7,04
DHCW-200		26/18	Water 7/12	3,0	153	50,1	365×365×164		1,5		12,40
DH-250	900	10/22	Water 60/40	3,6	49	5,4	420×380×152		1,5	250	9,30
DHCW-250		26/18	Water 7/12	3,1	77	67,6	425×425×164		2,0		15,37
DH-315	1600	10/22	Water 60/40	6,5	58	17,9	470×510×152		2,1	315	11,75
DHCW-315		26/18	Water 7/12	5,2	90	13,4	560×515×164		3,0		21,60
DH-315M	2000	10/22	Water 60/40	8,1	98	3,6	480×520×132		2,4	315	14,39
DHCW-315		26/18	Water 7/12	6,5	133	20,1	560×515×164		3,0		21,60
DH-355	2000	10/22	Water 60/40	8,1	61	28,3	600×510×152		2,4	355	13,34
DHCW-355		26/18	Water 7/12	6,6	55	21,6	605×605×164		2,4		25,43

Table 4. Duct water heat exchangers with rectangular connections

Type	Supply air volume, m ³ /h	Air temp. in/out, °C	Capacity*, kW	Air pressure drop, Pa	Hydraulic pressure drop, Pa	B×H×L, mm	Pipe connection	Internal volume, dm ³	B1×H1, mm	Weight, kg
SVK-400×200-2	850	0/22	6,3	37	31	480×320×100	½"	0,8	400×200	5,0
SVK-400×200-4	850	-23/22	12,8	69	33	517×320×130	½"	1,3	400×200	7,0
SVK-500×250-2	1500	0/22	11,1	70	14	617×320×100	½"	0,9	500×250	6,0
SVK-500×250-4	1500	-23/22	22,6	131	17	617×320×130	½"	1,5	500×250	9,0
SVK-500×300-2	1800	0/22	13,3	65	24	617×380×100	½"	1,1	500×300	7,0
SVK-500×300-4	1800	-23/22	27,2	122	26	623×380×130	¾"	2,1	500×300	12,0
SVK-600×300-2	2300	0/22	17	73	40	717×380×100	½"	1,2	600×300	8,0
SVK-600×300-4	2300	-23/22	34,7	137	25	723×380×130	¾"	2,3	600×300	13,0
SVK-600×350-2	2600	0/22	19,2	65	21	717×440×100	½"	1,5	600×350	9,0
SVK-600×350-4	2600	-23/22	39,2	123	25	723×440×130	¾"	2,8	600×350	15,0
SVK-700×400-2	4000	0/22	29,6	120	52	817×500×100	½"	3,1	700×400	12,0
SVK-700×400-4	4000	-23/22	60,3	226	53	830×500×130	1"	6,4	700×400	18,0
SVK-800×500-2	4500	0/22	33,3	92	14	923×560×100	¾"	4,1	800×500	14,0
SVK-800×500-4	4500	-23/22	67,9	172	14,2	937×560×130	1 ¼"	8,5	800×500	21,0
SVK-1000×500-2	5700	0/22	42,1	94	22	1123×560×100	¾"	4,9	1000×500	16,0
SVK-1000×500-4	5700	-23/22	86	177	23	1137×560×130	1 ¼"	10,1	1000×500	25,0

* Internal fluid temperature 80/60 °C.

There are shown technical data of heat exchangers: capacity, air pressure drop, hydraulic pressure drop at different air flows and parameters (cooling capacities are calculated at 50 % relative humidity) in tables 1–4.

Weights, dimensions and dimensions of the connections of heat exchangers are also specified.

INSTALLATION OF HEAT EXCHANGERS

Unit is for indoor use only at temperature between +5 and +40°C. Coolers must be installed in position that air flow direction would be horizontal.

In heat exchangers the water flow direction through the heat exchanger must always be opposite to the air flow direction.

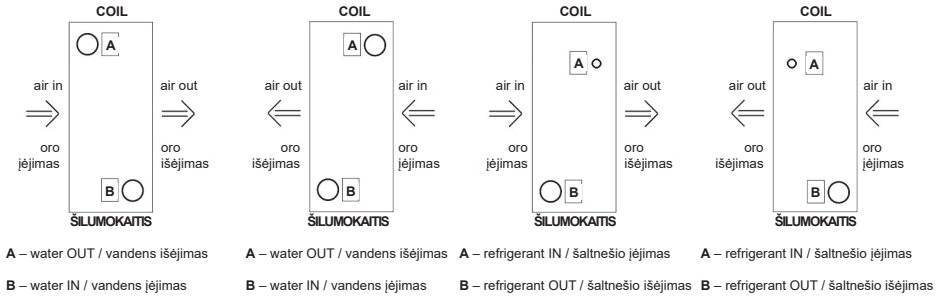

Fig. 4a. Fluid flow direction in respect of air flow in coils with rectangular connetions

DH and DHCW heat exchangers are equipped with return water temperature sensor. It is mounted depending on fluid flow direction fig. 4b.

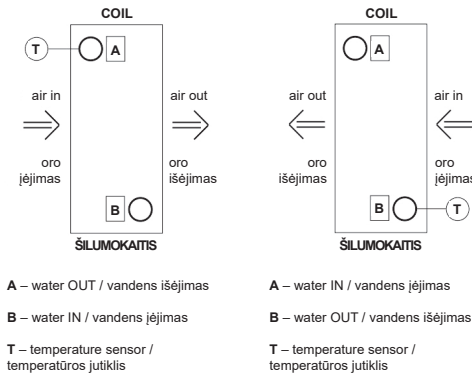

Fig. 4a. Fluid flow direction in respect of air flow in heat exchangers with round connections

Heat exchangers should be carefully flushed out with water before the installation. DCF heat exchangers is filled with nitrogen gas which must be released through the valve.

⚠ Attention!
 When screwing fitting pipes on to the system, hold them with a tube wrench, as in Fig. 5a.

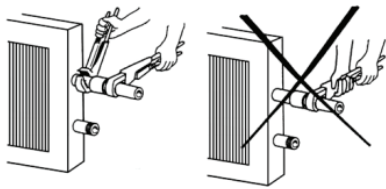

Fig. 5a. Heat exchanger fitting pipe connection

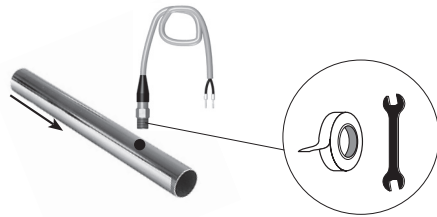

Fig. 5b. Return water sensor installation

**Attention!**

Fig. 5a shows correct heat exchanger fitting pipe connection. Wherever possible, heat exchanger pipes should be connected in such a way as to ensure free access to pipe work for maintenance. When carrying out installation of heat exchanger pipes, make sure that liquid (evaporative refrigerant) supply is completely disconnected.

In fig. 5b shown sensor must be thermally insulated. Sensor is connected to the controller terminals (see automatic control manual).

Before start-up of the air handling unit, working evaporative refrigerant should be injected into the heat exchangers. The heat exchanger can be fill up with water and 30 percent with ethylene glycol liquid.

The technical documentation of ethylene glycol liquid, make inquiries to producers.

Never pour glycol down a drain; collect it in a receptacle and leave it at a recycling centre or the like. Glycol is highly dangerous to consume and can cause fatal poisoning or damage the kidneys. Contact a doctor! Avoid breathing glycol vapour in confined spaces. If you get glycol in your eyes, flush them thoroughly with water (for about 5 minutes).

CLEANING AND INSPECTION OF HEAT EXCHANGERS

The plates of heat exchangers and droplet eliminators (fig. 6) should be cleaned regularly to ensure the most effective heat exchange between the surface of coil and the air flow passing through it.

Cleaning frequency should be set depending on air purity and in-line filters.

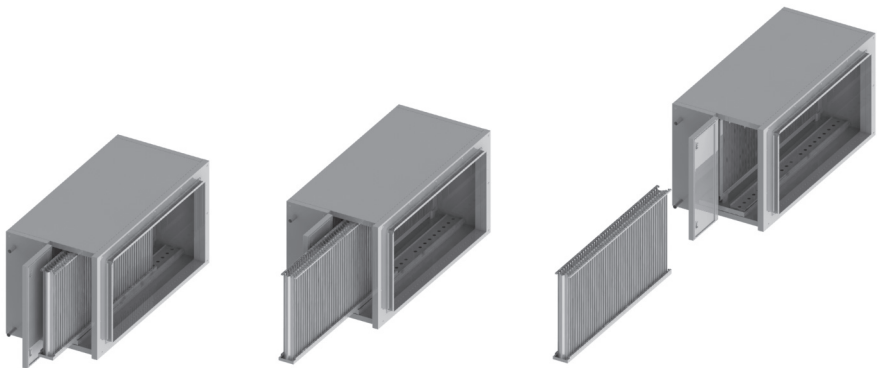

Fig. 6. The droplet eliminator pulling out from the section

Always clean the heat exchanger against the regular direction of airflow. Make sure that the coils are purged of air. If a droplet eliminator is fitted, remove it and flush it clean with water. Also check that the condensate drain is not clogged.

WATER TRAP INSTALLATION

The bend of the water trap can be repositioned by turning it to the right or the left. The drain line from the water trap must be arranged so that it will not damage adjacent unit sections or building elements. If the drain line is run through cold spaces, it should be insulated to prevent freezing. A heating cable may be required.

Water trap installation for a unit section mounted on the suction side

Since the fans in most air handling units are last in the chain of functions and generate sub-atmospheric pressure inside the unit, it is very important to correctly install the water trap. Because of that reason condensate can be hardly eliminated from the air handling unit and the technical premise may get covered with condensate. Height H_1 must be at least equivalent in mm to half of the negative pressure inside the unit in mm water gauge. Height H_2 must be at least equivalent in mm to the negative pressure inside the unit in mm water gauge.

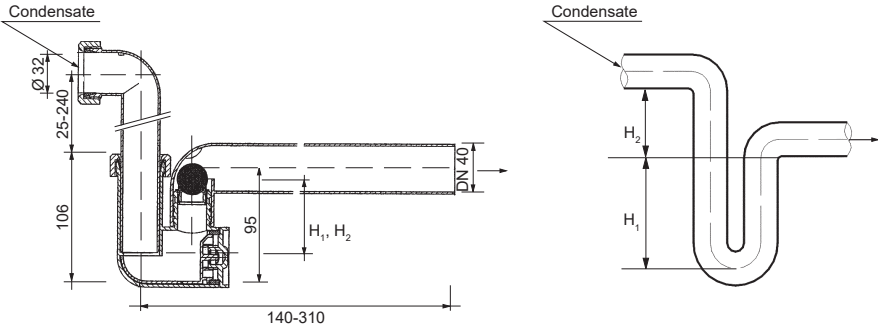

Fig. 7. The principle scheme of correct drainage siphon installation

There is shown the principle scheme of correct drainage siphon installation in fig. 7.

	<p>Precaution: The drainage siphon should be mounted on the outlet fitting pipe of every drip tray for complete condensate drainage from the air handling unit and prevention of penetration of offensive odours from an effluent into the ventilation system.</p>
--	-------------------------------------------------------------------------------------------------------------------------------------------------------------------------------------------------------------------------------------------------------------------------------

Water trap installation for a unit section mounted on the pressure side

Since the fans in most air handling units are not last in the chain of functions and generate over-atmospheric pressure inside the cooling section. In such case the consisted condensate can be easily removed from AHU and there will be no strict requirements for siphon's installation. A drainage siphon is enough with a minimum rake.

RECOMMENDATION: The drainage siphon must be installed in connection with not less size pipe diameter.

UAB KOMFOVENT

TECHNINĖS PRIEŽIŪROS SKYRIUS / SERVICE AND SUPPORT

Tel. +370 5 200 8000
service@komfovent.com

ООО «КОМФОВЕНТ»

Россия, Москва
ул. Выборгская д. 16,
стр. 1, 2 этаж, 206 офис
Тел. +7 499 673 22 73
info.oka@komfovent.com
www.komfovent.ru

ООО «КОМФОВЕНТ»

390017 г. Рязань
Рязжское шоссе, 20 литера Е, пом Н6
Тел.: +7 491 255 95 71
info.oka@komfovent.com
www.komfovent.ru

ИООО «Комфовент»

Республика Беларусь, 220125 г. Минск,
ул. Уручская 21 – 423
Тел. +375 17 266 5297, 266 6327
info.by@komfovent.com
www.komfovent.by

Komfovent AB

Ogärdesvägen 12B
433 30 Partille, Sverige
Тел. +46 31 487 752
info_se@komfovent.com
www.komfovent.se

Komfovent Oy

Muuntotie 1 C1
FI-01 510 VANTAA
Тел. +358 0 408 263 500
info_fi@komfovent.com
www.komfovent.com

Komfovent GmbH

Konrad-Zuse-Str. 2a, 42551 Velbert,
Deutschland
Тел. +49 0 2051 6051180
info@komfovent.de
www.komfovent.de

SIA Komfovent

Bukaišu iela 1,
LV-1004 Rīga
Тел. +371 24 664433
info@komfovent.lv
www.komfovent.lv

www.komfovent.com

PARTNERS

AT	J. PICHLER Gesellschaft m. b. H.	www.pichlerluft.at
BE	Ventilair group	www.ventilairgroup.com
	ACB Airconditioning	www.acbairco.be
CZ	REKUVENT s.r.o.	www.rekuvent.cz
CH	WESCO AG	www.wesco.ch
	SUDCLIMATAIR SA	www.sudclimatair.ch
	CLIMAIR GmbH	www.climair.ch
DK	Øland A/S	www.oeland.dk
EE	BVT Partners	www.bvtpartners.ee
FR	AERIA	www.aeria-france.fr
HR	Microclima	www.microclima.hr
HU	AIRVENT Légtechnikai Zrt.	www.airvent.hu
	Gevent Magyarország Kft.	www.gevent.hu
	Merkapt	www.merkapt.hu
IR	Fantech Ventilation Ltd	www.fantech.ie
IS	Blikk & Tæknibjónustan ehf	www.bogt.is
	Hitataekni ehf	www.hitataekni.is
IT	Icaria srl	www.icariavmc.it
NL	Ventilair group	www.ventilairgroup.com
	DECIPOL-Vortvent	www.vortvent.nl
NO	Ventistål AS	www.ventistal.no
	Thermo Control AS	www.thermocontrol.no
PL	Ventia Sp. z o.o.	www.ventia.pl
SE	Nordisk Ventilator AB	www.nordiskventilator.se
SI	Agregat d.o.o	www.agregat.si
SK	TZB produkt, s.r.o.	www.tzbprodukt.sk